

MODULO IF96003 USCITA IMPULSI

Abbinato a strumenti della serie Nemo 96HD/HD+ consente la ripetizione a distanza del conteggio dell'energia. Due uscite indipendenti ed isolate possono essere liberamente associate al conteggio dell'energia attiva e/o reattiva. In ogni strumento è possibile inserire un massimo di due moduli ottenendo così quattro uscite impulsi. Il modulo può essere inserito liberamente in qualsiasi delle quattro sedi previste (vedi disegno).

PARAMETRI PROGRAMMABILI

Parametri programmabili per ogni singola uscita
Energia associata: attiva o reattiva
Peso impulso: 1imp/0,01-0,1-1-10-100kWh(kvarh)
1imp/1-10MWh(Mvarh).
Durata impulso: 50-100-200-300ms

USCITE

2 optorelè con contatto SPST-NO libero da potenziale
Portata contatti: 110Vcc/ca 50mA

ATTENZIONE!

L'inserimento dei moduli deve essere effettuato con lo strumento non alimentato.

MODULE IF96003 PULSE OUTPUT

Used with meters of Nemo 96HD/HD+ series, it allows the remote repetition of energy count. Two independent and insulated outputs can be freely associated to active and/or reactive energy count. In every meter it is possible to connect a maximum of two modules obtaining, in this way, four pulse outputs. The module can be freely connected in any of the four slots suited to the purpose (see drawing).

PROGRAMMABLE PARAMETERS

Programmable parameters for each output
Associated energy: active or reactive
Pulse weight: 1 pulse/0,01-0,1-1-10-100kWh(kvarh)
1 pulse/1-10MWh(Mvarh)
Pulse duration: 50-100-200-300ms

OUTPUTS

2 optorelays with potential-free SPST-NO contact
Contact range: 110V direct current/alternating current 50 mA

ATTENTION!

Modules must be connected with non-fed meter.

MODULE IF96003 SORTIE IMPULSION

Raccordé aux centrales de type Nemo 96HD/HD+, il permet la transmission à distance du comptage de l'énergie. Deux sorties indépendantes et isolées peuvent être librement associées au comptage de l'énergie active et/ou réactive. Il est possible de connecter au maximum deux modules en obtenant, de cette façon, quatre sorties impulsions. Le module peut être connecté, au choix dans un des quatre slots prévus à cet effet (voir dessin).

PARAMETRES PROGRAMMABLES

Paramètres programmables pour chaque sortie :
Energie associée: active ou réactive
Poids impulsion: 1 impulsion/0,01-0,1-1-10-100kWh(kvarh)
1 impulsion/1-10MWh(Mvarh)
Durée de l'impulsion: 50-100-200-300ms

SORTIES

2 optorelais avec contact SPST-NO libre de potentiel
Etendue des contacts : 110V dc/ac 50mA

ATTENTION!

Lors du montage des modules, le Nemo 96HD/HD+ doit impérativement être hors tension.

MODUL IF96003 IMPULSAUSGÄNGE

In Verbindung mit dem Gerät Nemo96HD/HD+ ist die Fernauslesung der Energiezähler möglich. Zwei voneinander unabhängige und potentialfreie Ausgänge können dem Wirkenergiezähler und/oder dem Blindenergiezähler zugeordnet werden. Jeder Nemo96HD kann maximal zwei Impulsausgangmodule aufnehmen, d.h. es stehen insgesamt vier Impulsausgänge zur Verfügung.

PROGRAMMIERBARE PARAMETER

Gilt für jeden einzelnen Impulsausgang.
Messgröße: Wirkenergie oder Blindenergie
Impulswertigkeit: 1 Impuls/0,01-0,1-1-10-100 kWh(kvarh)
1 Impuls/1-10MWh (Mvarh)
Impulsdauer: 50-100-200-300ms

AUSGÄNGE

Zwei Optorelais SSR mit potentialfreien Arbeitskontakt SPST-NO
Kontaktlast: 110V DC/AC; 50mA

ACHTUNG!

Das Modul darf nur bei ausgeschaltetem Gerät (ohne Versorgungsspannung) eingesteckt bzw. entfernt werden.



Cod. IF96003

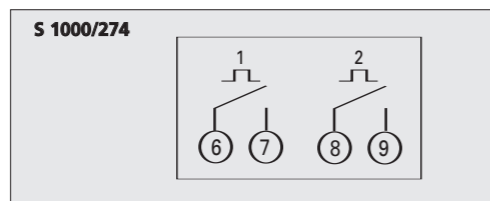

Inserimento 2 moduli 2-module connection Branchement de 2 modules Anschluss für 2 Module

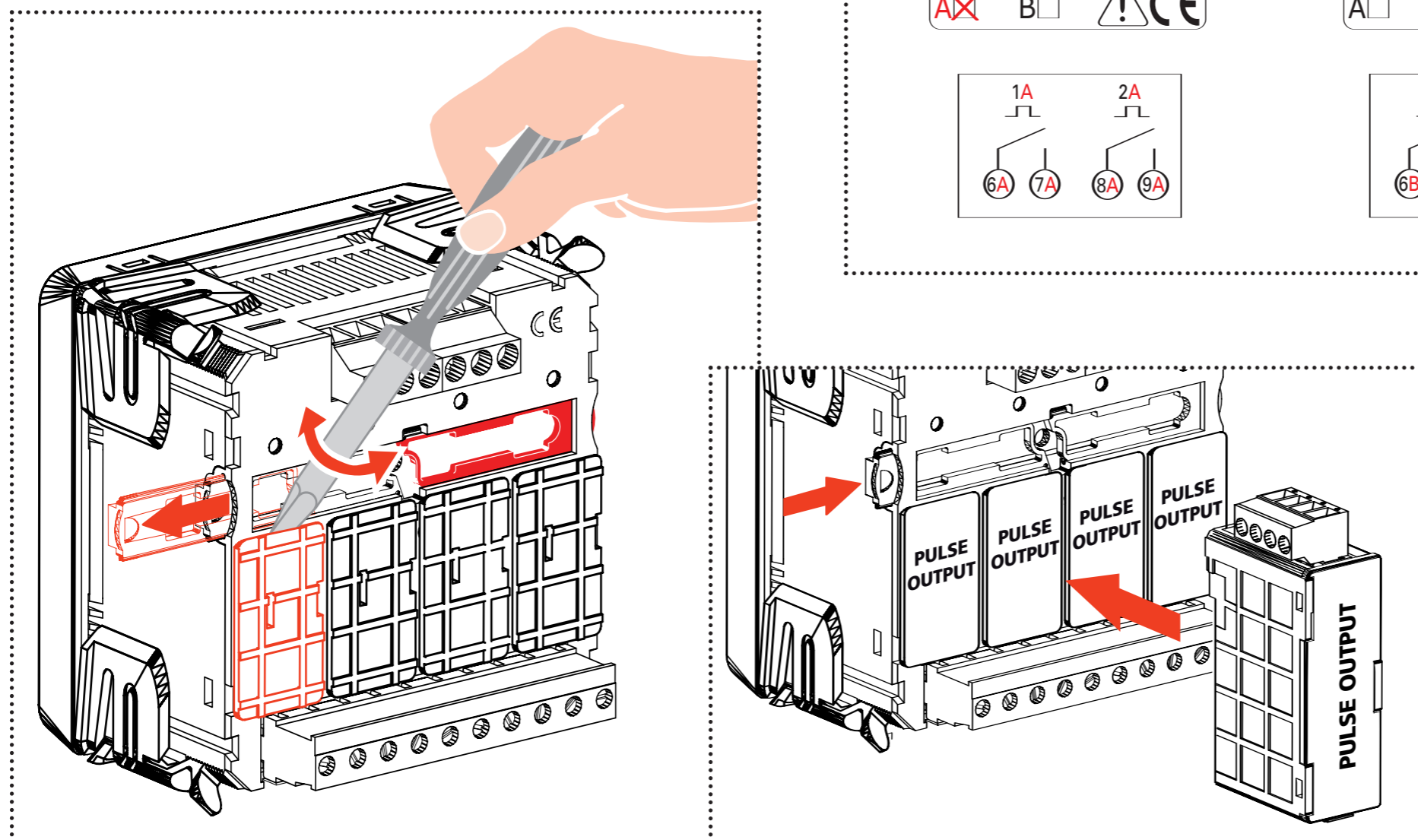
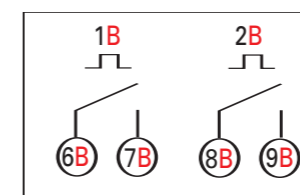
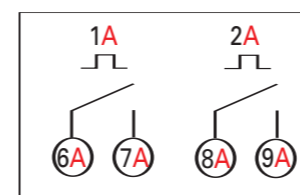
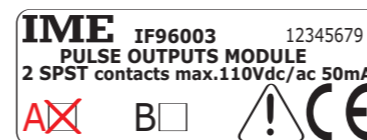

ISTRUMENTI MISURE ELETTRICHE SpA

Via Travaglia 7
20094 CORSICO (MI)
ITALIA
Tel. 02 44 878.1
Fax 02 45 03 448
+39 02 45 86 76 63
www.imeitaly.com
info@imeitaly.com



Ingresso programmazione
 Input programming
 Entrée programmation
 Programmierung starten



Indietro una pagina
 A page backward
 Une page en arrière
 Eine Seite zurück



Uscita senza salvataggio
 Exit without backup
 Sortie sans sauvegarde
 Programmierung beenden
 (ohne Speicherung)



*= Valido solo quando ci sono più moduli
 *= Valable uniquement si plusieurs modules

*= Valid only when there are many modules
 *= nur wenn mehrere Module eingesteckt sind

***Modulo successivo**
 Next module
 Module suivant
 Nächstes Modul

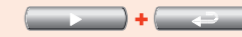

***Modulo precedente**
 Previous module
 Module précédent
 Vorheriges Modul

PASSWORD 1

PASSWORD 1
 MOT DE PASSE 1
 KENNWORT 1



PREMERE + VOLTE

PRESS MANY TIMES
 APPUYER PLUSIEURS FOIS
 MEHRMALIGES DRÜCKEN



ENERGIA ASSOCIATA 1

ASSOCIATED ENERGY 1
 ENERGIE ASSOCIEE 1
 MESSGRÖßE 1



PESO IMPULSO 1

PULSE WEIGHT 1
 POIDS IMPULSION 1
 IMPULSWERTIGKEIT 1



DURATA IMPULSO 1

PULSE DURATION 1
 DUREE IMPULSION 1
 IMPULSDAUER 1



PASS PASS
 0000 1000

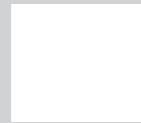

---b ---b
 TYPE TYPE
 PLS 1 6-1 PLS 1 6-1

---b ---b ---b ---b ---b
 UAL UAL UAL UAL UAL
 00 0.1 10 100 1000 kWh
 PLS 1 6-1 PLS 1 6-1 PLS 1 6-1 PLS 1 6-1 PLS 1 6-1

---b ---b
 UAL UAL
 10 100 MWh
 PLS 1 6-1 PLS 1 6-1

---b ---b ---b ---b
 dUr dUr dUr dUr
 50 100 200 300
 PLS 1 6-1 PLS 1 6-1 PLS 1 6-1 PLS 1 6-1

ENERGIA ASSOCIATA 2

ASSOCIATED ENERGY 2
 ENERGIE ASSOCIEE 2
 MESSGRÖßE 2



PESO IMPULSO 2

PULSE WEIGHT 2
 POIDS IMPULSION 2
 IMPULSWERTIGKEIT 2



DURATA IMPULSO 2

PULSE DURATION 2
 DUREE IMPULSION 2
 IMPULSDAUER 2



PASSWORD 2

PASSWORD 2
 MOT DE PASSE 2
 KENNWORT 2



SALVA

SAVE
 SAUVE
 SAVE

---b ---b
 TYPE TYPE
 PLS 2 8-9 PLS 2 8-9

---b ---b ---b ---b ---b
 UAL UAL UAL UAL UAL
 00 0.1 10 100 1000 kWh
 PLS 2 8-9 PLS 2 8-9 PLS 2 8-9 PLS 2 8-9 PLS 2 8-9

---b ---b
 UAL UAL
 10 100 MWh
 PLS 2 8-9 PLS 2 8-9

---b ---b ---b ---b
 dUr dUr dUr dUr
 50 100 200 300
 PLS 2 8-9 PLS 2 8-9 PLS 2 8-9 PLS 2 8-9

PASS
 0000

SAVE